



E-BIKE  
CENTRAL MOTOR DRIVE SYSTEM  
(SYSTEM TYPE: BDS01)  
USER'S GUIDE

Version: V1.0

SUZHOU BAFANG ELECTRIC MOTOR SCIENCE-TECHNOLOGY CO.,LTD

Continuously exceed customer expectations

Thanks for using Bafang products

[www.szbf.com](http://www.szbf.com)

## Company Introduction

Suzhou Bafang Electric Motor Science- Technology Co., Ltd is located in Suzhou Industrial Park, at the center of Yangtze River Delta, endowed with convenient transportation for both international and domestic business. Bafang company was founded in 2003, which is a high-tech enterprise of electric drive system, combining design, R&D, manufacturing and sales.

We have more than 260 employees, more than 35 senior engineers in R & D department, be able to accept of various challenging projects. Our well-established quality control system, advanced motor and controller production, and testing equipment, as well as high-level R&D and testing center enable us to deliver high quality products consistently. Now our annual production capacity reaches 1,000,000 sets.

Your dream, our goal!

System composition



display speed detecting magnet



drive unit

speed detecting sensor

## Catalog

Central motor 1	1.1 Scope of application and numbering rule-----5 1.2 Material and waterproof grade-----5 1.3 Main technical parameters-----6 1.4 Installation diagram-----6 1.5 Installation procedure-----8
Display 2	2.1 Material and waterproof grade-----14 2.2 Dimension-----14 2.3 Installation instruction-----15 2.4 Button definition-----16 2.5 Display Area-----16 2.6 Power on-----17 2.7 Adjust-----18 2.8 Parameter setting-----21 2.9 Power off-----23 2.10 Malfunction Code-----23
Speed detecting sensor 3	3.1 Installation dimension-----25 3.2 Installation-----25
System connection diagram 4	4 System connection diagram-----27
Notes 5	5 Notes-----28
After service & warranty 6	6 After service & warranty-----29
Packing list 7	7 Packing list-----30

## 1 Central motor

- ★ Can be installed on standard bike frame easily.
- ★ High starting torque, Max torque $\geq$ 80Nm, good performance on climbing.
- ★ Double clutch is used on drive unit, more safety.
- ★ Speed sensor and torque sensor can be applied, controller integrated.
- ★ High efficiency, low consumption, long travel mileage.

### 1.1 Scope of application and numbering rule

Countermark serial number on motor casing as following:

BBS01 36V 250W

15A 25km/h

13010001

1. "BBS01": motor type(speed sensor); "BBS02": motor type(speed sensor with coaster brake); "BBT": motor type (torque sensor)
2. "36V": rated voltage; 250W: rated power.
3. "15A": limited current, 25km/h: max speed.
4. "1301": production date, produced in January of 2013.
5. "0001": serial number.

### 1.2 Material and waterproof grade

Die-cast aluminum electrophoresis black treatment, working environment temperature:-25 $^{\circ}$ C-55 $^{\circ}$ C, waterproof grade: IP65.

### 1.3 Main technical parameters

Voltage		DC36V						
Limit current		15A						
Limit speed		25KM/H						
Motor weight		3.7KG						
Chain wheel tooth		46T						
no-load value		Rated value					Max value	
current (A)	speed (RPM)	Output power (W)	speed (RPM)	efficiency (%)	torque (Nm)	current (A)	MAX torque	MAX efficiency (%)
≤1.0	83±5	250	78±5	≥80%	≥30	≤9	≥80N.m	≥80%

Above parameters as the default parameters, can be customized according to customer requirements.

### 1.4 Installation diagram

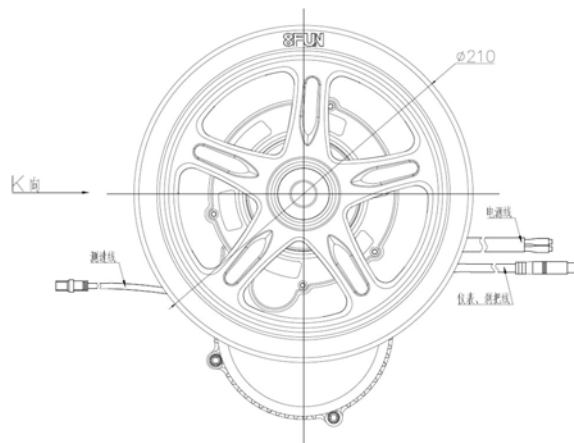





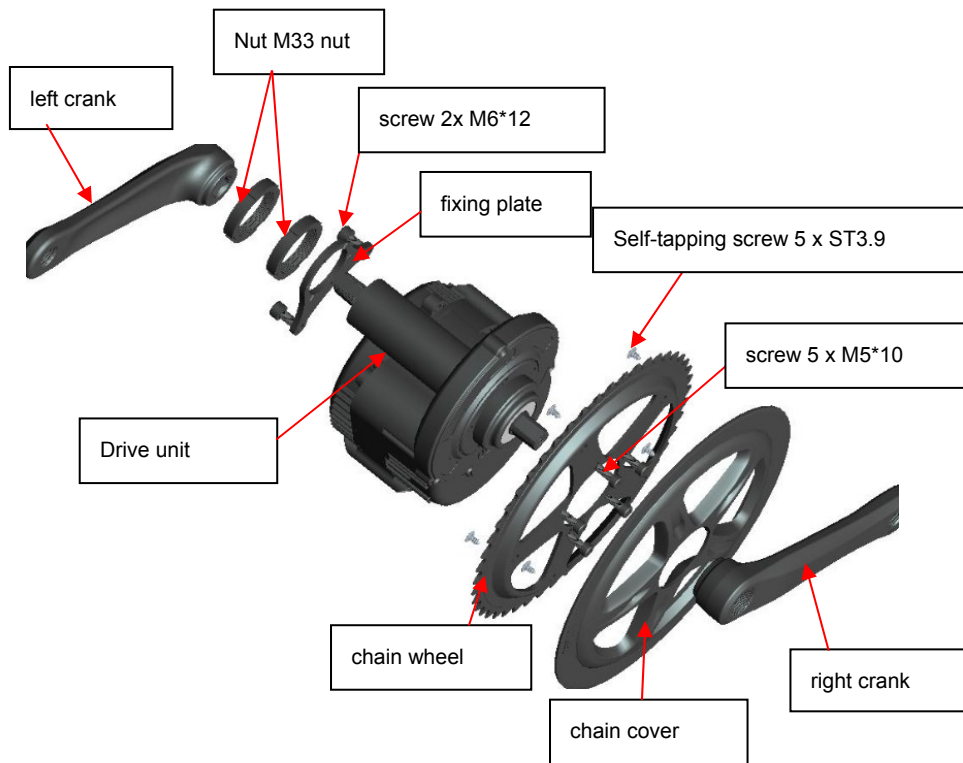

### 1.5 Installation procedure

1. Open the package and take out the drive unit and accessories;  
And check the specification whether it is correct.
2. Fix the chain wheel on drive unit with 5pcs screw M5\*10, (see picture 1), then fix chain cover on chain wheel with 5pcs screw ST3.9.



Picture1

3. Fix the drive unit axle tube on frame bottom bracket (see picture 2, picture 3)

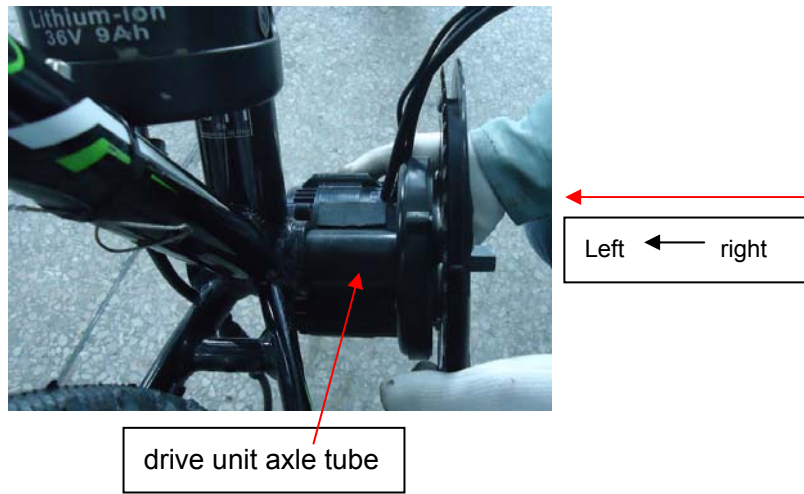

Picture 2



Picture 3

ensure thread of axle tube extend bottom bracket more than 10mm

4. The surface with teeth of fixing plate towards inside, then fix the plate on drive unit with 2pcs M6\*10.(see picture 4,picture 5)



the surface with teeth of fixing plate

Picture 4

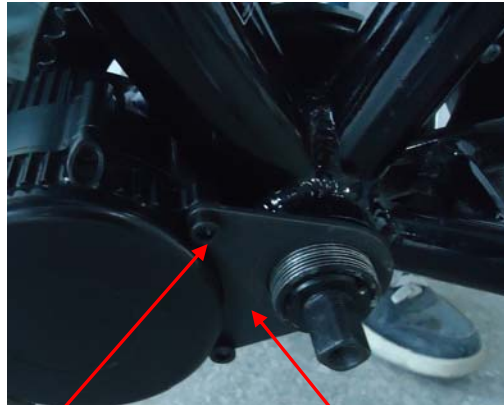

2xM6 nut

Outside surface without teeth

Picture 5

5. Hold the drive unit near to bicycle fork, force less than 5KG, tight 1st nut M33 onto axle tube with force:30-40N.m (see picture 6)

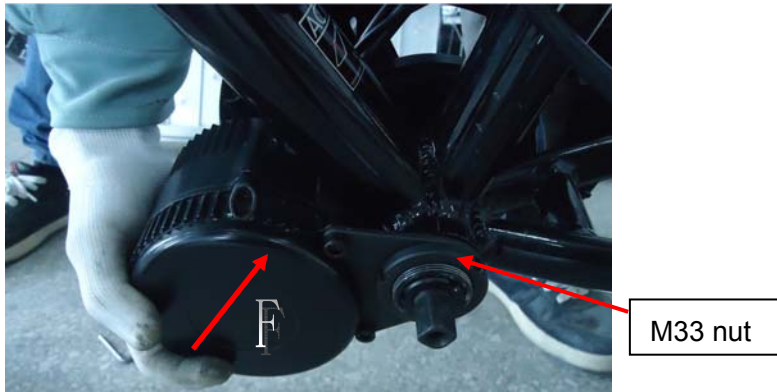

Picture 6

6. Fix 2<sup>nd</sup> nut M33 onto axle tube, tightening force:30-40N.m(see picture 7)

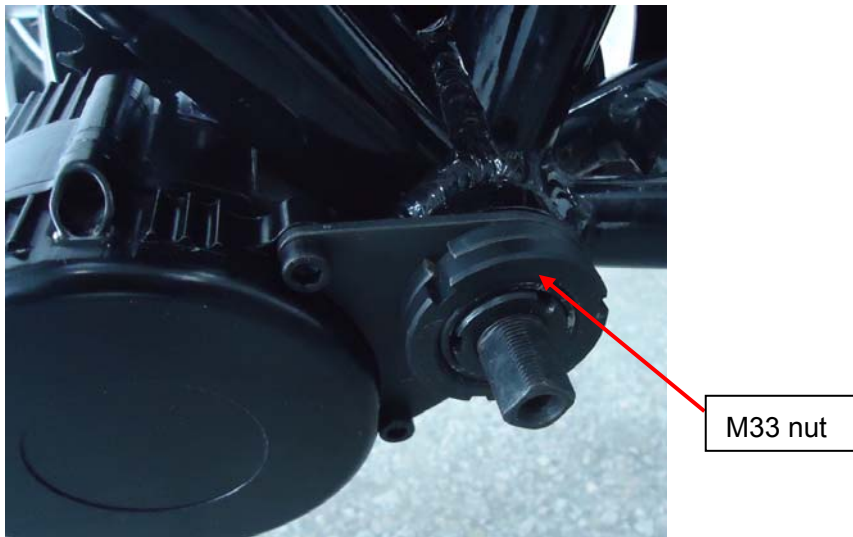

Picture 7

7. Fix the left crank on the bike with M8 inner hexagon screw. Tightening force:35-40N.m (see picture 8)

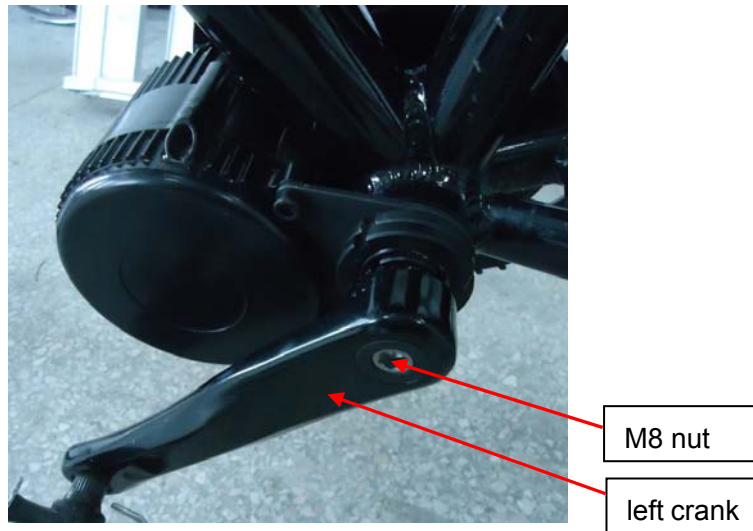

Picture 8

8. Fix the right crank on the bike with M8 inner hexagon screw. Tightening force: 35-40N.m (see picture 9)

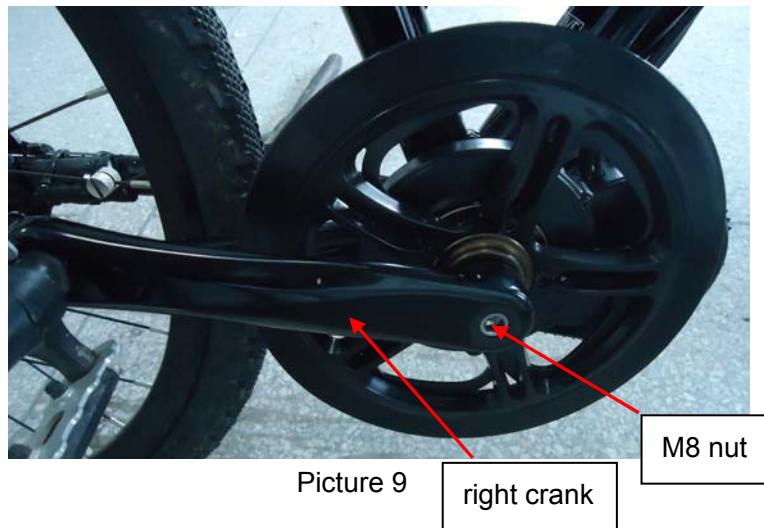

Picture 9

9. Connect all cables for battery, display, speed detecting sensor and so on (see picture 10-12)

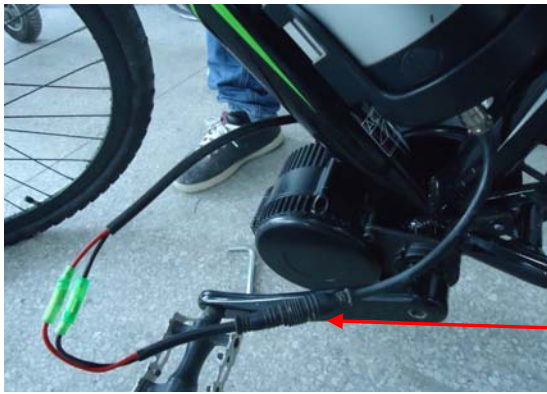

Water proof connector for battery



Water proof connector for display



Water proof connector for speed detecting sensor

## 2 C950 Display

### 2.1 Material and waterproof grade

Display's casing use black/silver ABS materials, display window use acrylic white transparent material.

Working temperature of display: - 20°C- 80°C.

Waterproof grade: IP65.

Ultrasonic is used for welding casing and display window.

### 2.2 Dimension (unit: mm)

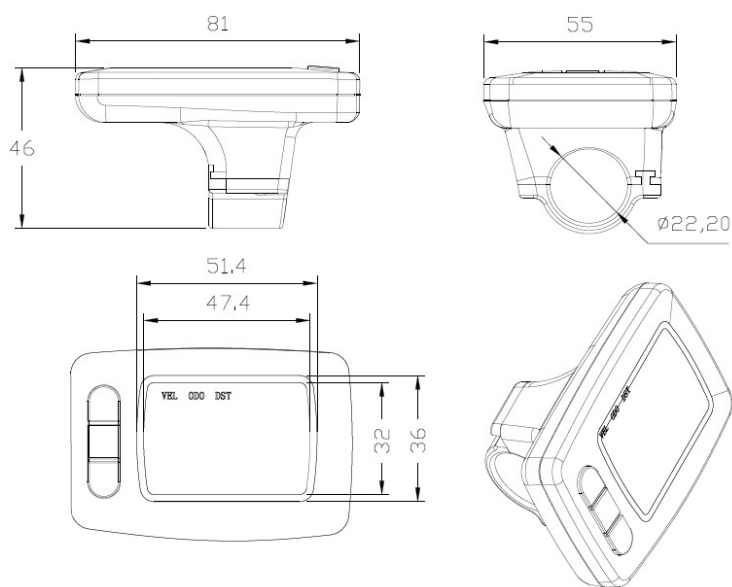



### 2.3 Installation instruction

Fix the display onto the handlebar and adjust to an appropriate visual angle, use a screw to fix the carrier onto bottom casing, then plug display connector with controller connectors, that's all.

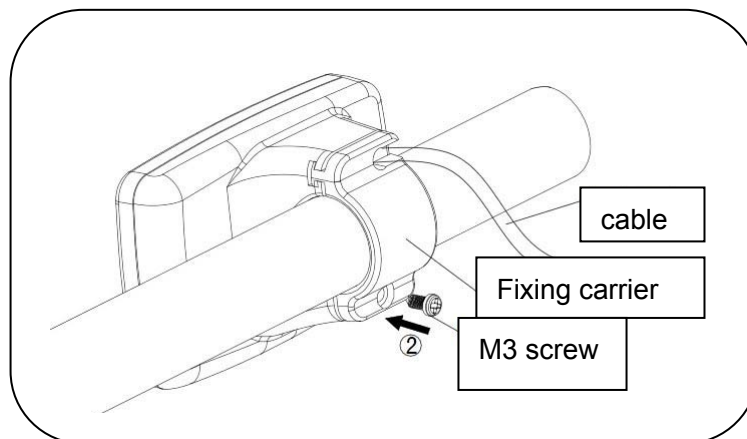
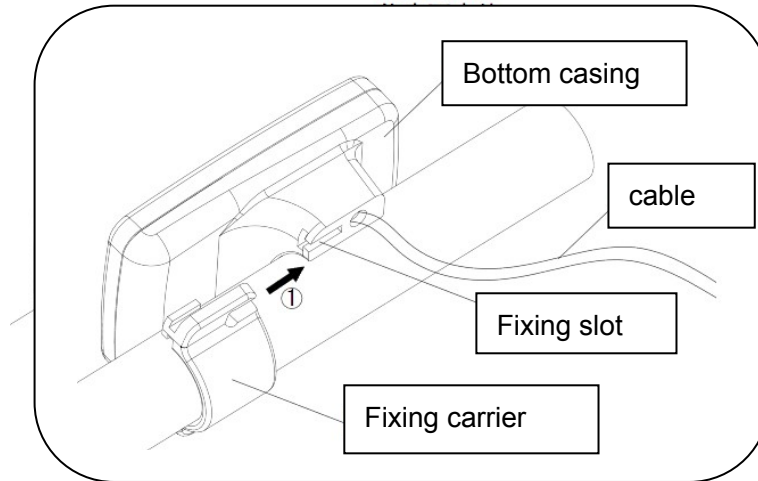





## 2.4 Button definition

C950 display is equipped with integrated buttons. The three buttons are installed on the left side. The shape and location is as below:



 System power switch

 Mode selection, together with  for setting

 back light switch, speed, mileage switch

## 2.5 Display Area

Display area includes battery capacity, riding mode, riding speed, single riding distance, total riding distance, and malfunction code of the electronic control system. Display area is as below:



Mode 1: walking assistant mode

Mode 2: economic mode

Mode 3: sports mode

Mode 4: power mode

## 2.6 Power on

First open the electric vehicle battery power.

Then press  to open system power (display below black font when power on)

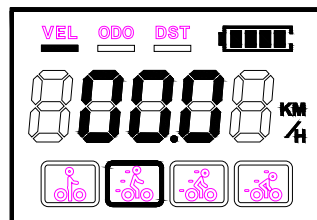

press  and choose favorite mode (refer to 2.7.1)



## 2.7 Adjustment

### 2.7.1 Mode selection

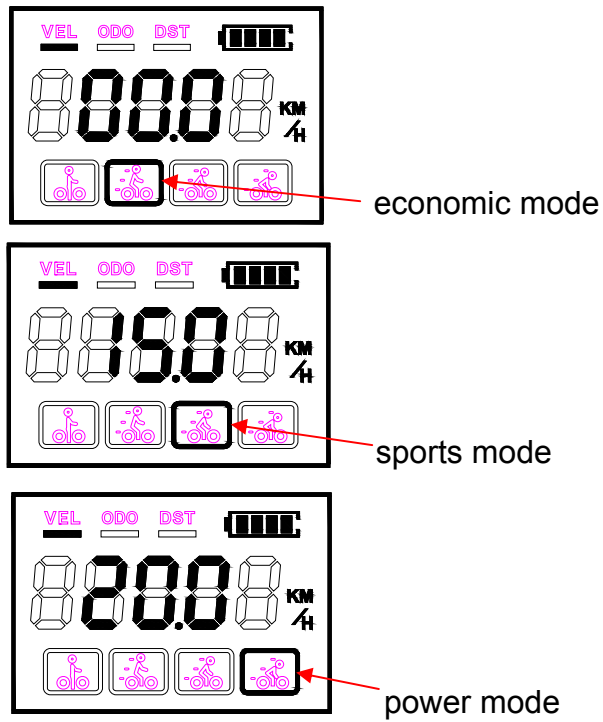
When e-bike power on, default mode is economic mode, press  0.5s to select mode, economic mode, sports mode and powerful mode will be cyclic in order as following:



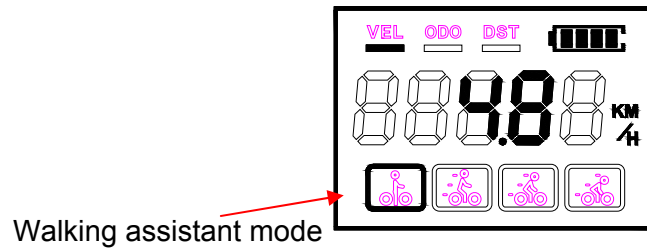

### 2.7.2 Walking Assistant

Hold  to enter walking assistant mode. The e-bike will go on at a uniform speed below 6 KM/H. Release , the e-bike goes back to previous state, interface is as below:



Warning: walking assistant function can only be used when the user is pushing the e-bike. Please don't use this function during riding.

### 2.7.3 Backlight turn On/Off

When the surrounding light is not enough or in the evening, turn on the backlight. Hold  0.5s to switch on the backlight. Hold  0.5s again to switch off the backlight.

### 2.7.4 Electric capacity display

When the battery capacity is overvoltage, the four battery segments are all lighted and the battery display frame will flash. When the

battery capacity is normal, the four battery segments lighten according to actual capacity. When the battery is under voltage, four battery segments switch off and battery display frame will flash with the frequency of 1 HZ, to remind user to recharge battery immediately.

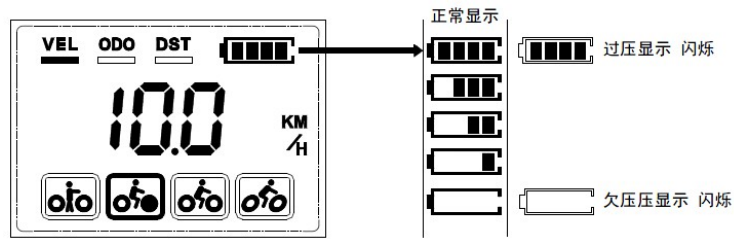

### 2.7.5 Speed and mileage switch

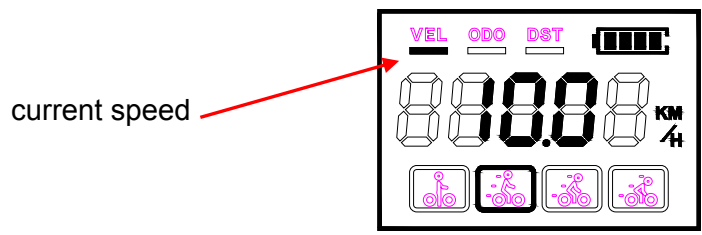

When power on, display shows the current speed automatically. Hold 3s switch to total distance. Hold the 3s again switch to single riding distance. Hold 3s again display will switch back to current speed. Do this in turns and interface is as below:







## 2.8 Parameter setting

Parameter setting includes: wheel diameter setting(8inch~28inch) and battery voltage setting (24V、36V). (The display is set already, do not set it again except the user has special requirements.)

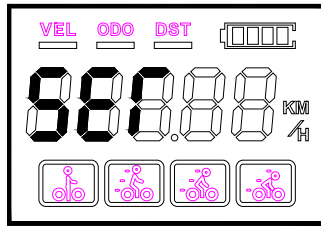
Put the power on, hold  and  together 3s to go the setting state, the interface is as below:





### 2.8.1 Wheel size setting

Hold  0.5s to go into the wheel size setting state, hold  0.5s to choose the right wheel size to make sure the speed and distance's

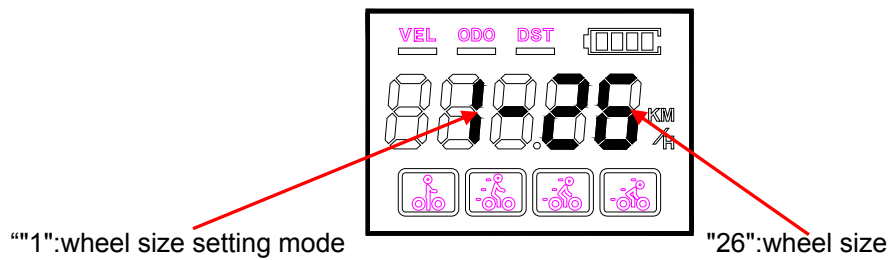
accuracy. Wheel size includes 08、10、12、14、16、18、20、22、26、28, choose in turn, interface is as below:



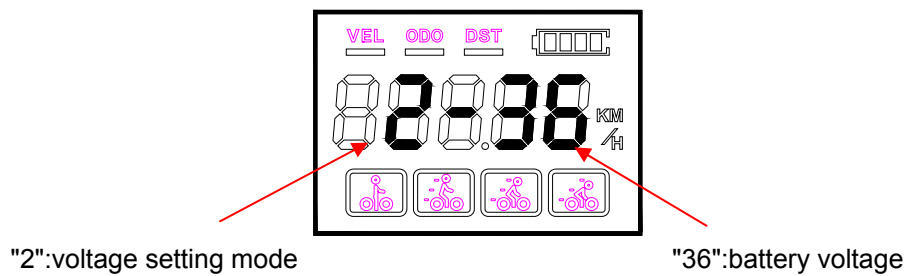

### 2.8.2 Battery voltage setting

Hold  0.5s to go to voltage setting interface, hold  0.5s to choose right voltage to make sure the display works normally. There are two options of 24V and 36V, choose it in turn, interface is as below:





### 2.8.3 Single mileage reset

Press  0.5s to go into the single riding distance setting interface, press  0.5s to clear the riding distance to zero, interface is as

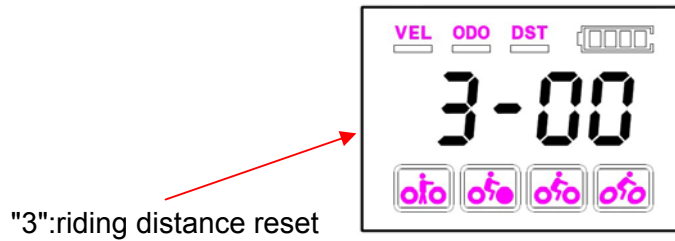
below:



#### 2.8.4 Exit the setting state

In the state of parameter setting, hold  and  for 3s to save the current settings and exit the setting interface.

Attention: With no action for 5 seconds, it will exit the setting interface automatically, and the adjustment will not be saved.

#### 2.9 Power off

Hold  for 3 seconds to switch off display.

Power will be switch off automatically with no action of e-bike for 5 minutes.

Suggestion: Switch off the battery and storage it in a right way, if the e-bike won't be used.

#### 2.10 Malfunction Code

If any errors appeared in electronic control system, the display will show the error code automatically. For example:



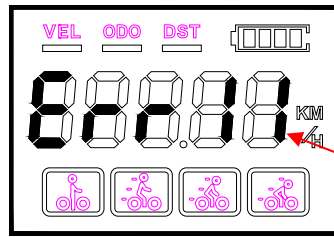

"11": Temperature sensor inside of controller has problem

Note: The display can't quit the malfunction code interface until the malfunction is solved. The e-bike can not work when it is in malfunction code display state.

No.	status data	meaning
1	0x01	Normal condition
2	0x03	Have braked
3	0x04	Brake lever didn't return to the location
4	0x05	Brake has problem
5	0x06	UVP
6	0x07	OVP
7	0x08	Motor hall sensor has problem
8	0x09	Motor phase wire has problem
9	0x10	Temperature inside of controller has reached the protection temperature
10	0x11	Temperature sensor inside of controller has problem
11	0x12	Current sensor has problem
12	0x13	Temperature inside of battery is un-normal
13	0x14	Temperature sensor inside of battery has problem
14	0x21	speed detect sensor inside of motor has problem
15	0x22	BMS communication has problem

16	0x23	light has problem
17	0x24	light sensor has problem
18	0x30	communication has problem

### 3 Speed detecting sensor

By measuring the wheel RPM, the signal is transferred to the controller, the speed and mileage will be showed on the display.

#### 3.1 Dimension

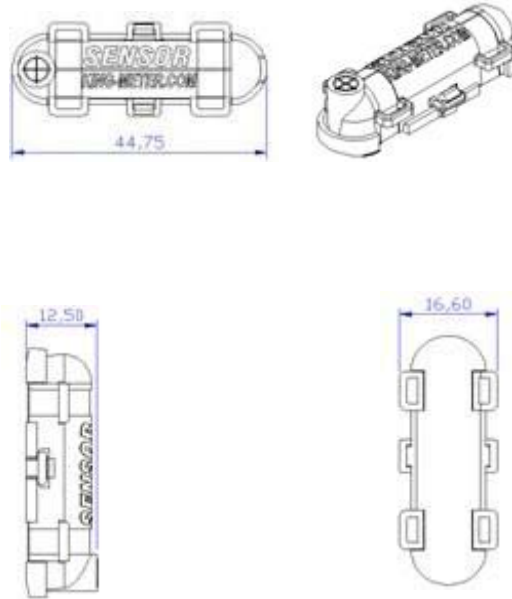

#### 3.2 Installation

1. Speed sensor component



2. Fix the speed sensor on appropriate position (bottom fork is suggested) of frame by ribbon.



tied by ribbon

3. Fix the magnet on spoke of rear wheel

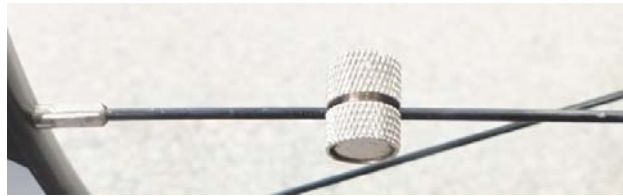

Note: magnet's surface must be parallelized with sensor's surface

4. Adjust the distance between speed sensor and magnet within 5mm

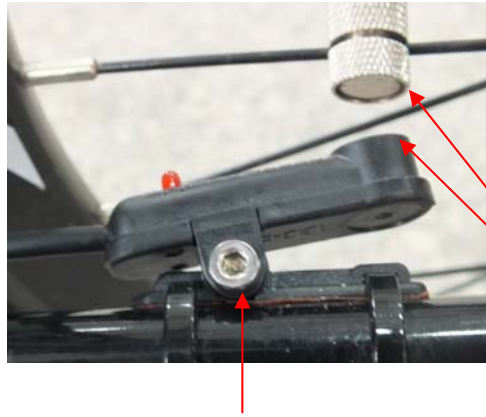

gap distance  $\leq 5\text{mm}$

fix the nut after adjust appropriate position

**4 Connection diagram**

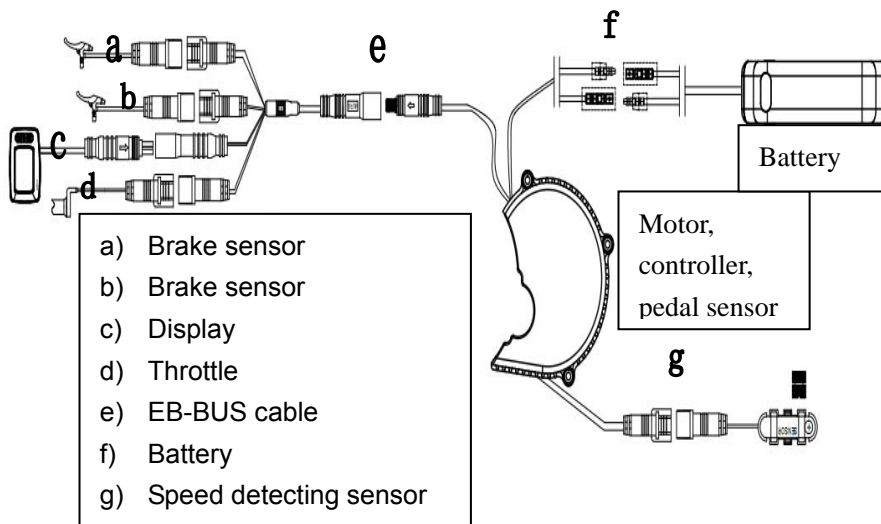

### 5 Notes

1. Should be stocked in a dry ventilated warehouse, do not be stocked in a humid, acidic and alkaline area, not coexist with magnetic object
2. Each connector inserted according to arrow to arrow
3. Avoid sharp objects impact on display
4. Avoid overload for long time when using
5. Avoid wading and soaking

## 6 After service and warranty

Suzhou Bafang Electric Motor Science-Technology Co Ltd (hereinafter to be referred as “Bafang”) warrants that the products bought from Bafang can be provided service freely if the products are non-conformities in material and workmanship within warranty period.

Timing and scope of warranty: Warranty period starts from date of Ex-factory, motor is within 30 months, controller, display, sensor and other electric components is within 18 months.

Bafang limited warranty does not cover or apply to the following:

- 1) Damage, failure and/or loss caused by refitting, neglect, improper maintenance, competition or commercial purpose, misuse, abuse or accident;
- 2) Damage, failure and/or loss caused by shipping;
- 3) Damage, failure and/or loss caused by improper installation, adjusting or repairing.
- 4) Damage, failure and/or loss irrelevant to material and workmanship, e.g., failure to follow instructions by consumers;
- 5) Damage, failure and/or loss caused by product’s appearance and surface change which doesn’t affect its function.
- 6) Damage, failure and/or loss caused by unauthorized service or installation;
- 7) Damage, failure or loss caused by normal wear and tear.

Bafang reserves the right to repair the components or replace the components, and is only responsible for repairing or replacing of the products.

In case bike manufacturers or dealers encounter quality problems when using or selling Bafang products, they can report the purchase order number and products’ serial number to Bafang technology service department who makes sure that if the products are under warranty or not. If it is under warranty, Bafang will offer repair or replacement for free. If it is out of warranty, Bafang still can

repair for customer, but the concerning material cost, labor cost, freight etc. will be paid by customer.

If you have Bafang components on complete bikes need to be repaired, please contact the bike manufacturer or dealer directly. If this warranty statement is against to Chinese current law, the Chinese law shall prevail. Bafang reserves the right to modify the terms without any announcing in advance.

### 7 Packing list

Two sets system per carton with packing list:

1.BBS01 motor	2sets
2.display	2sets
3.brake	2sets
4.EB-BUS	2pcs
5.fixing plate	2pcs
6.chain wheel and chain cover	2sets
7.crank	2sets
8.M5*10 nut	10pcs
9.M6*12 nut	4pcs
10.M33 nut	4pcs
11.ST 3.9 nut	10pcs
12.speed detecting sensor	2pcs
13.magnets	2pcs
14.specification	2pcs

Above components list is for reference only, it can be changed with different requirement.